

SHURflo

KITS FOR MODEL 2088-514-145

Issued: MR. 1-24-00

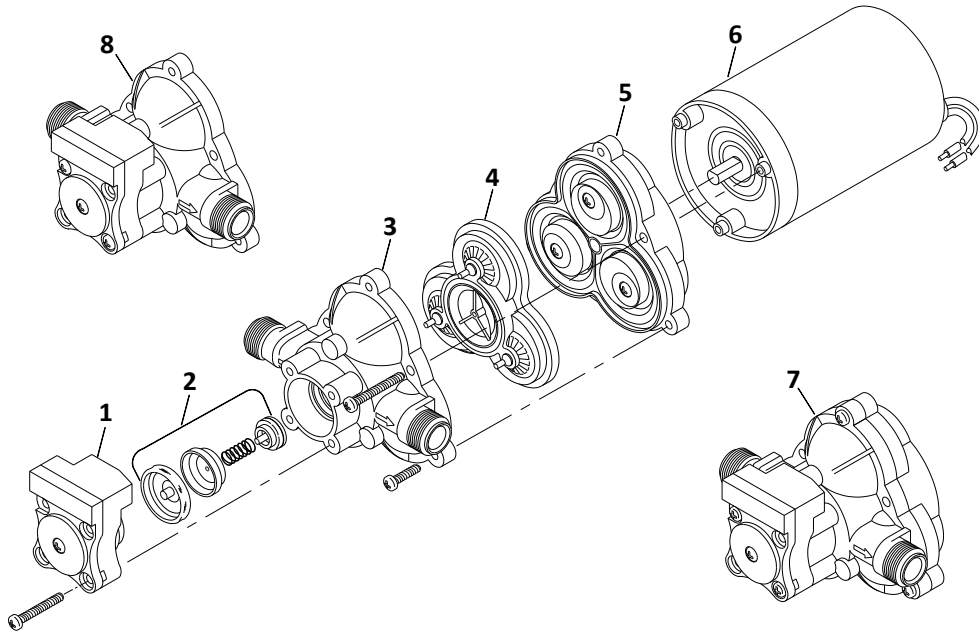

- | | |
|-------------------------------------|------------------|
| 1) Switch Assembly | 94-230-35 |
| 2) Check Valve Assembly | 94-237-00 |
| 3) Upper Housing | 94-231-30 |
| 4) Valve Assembly | 94-232-00 |
| 5) Diaphragm/Lower Housing | 94-238-03 |
| 6) Motor | 11-185-06 |
| 7) Complete Pump Head | 94-236-15 |
| 8) Upper Housing/Switch Assy | 94-231-20 |